

Flat roof - fdrhbi03b-01

flat roof, timber frame construction, ventilated, with dry lining, not suspended, other surface

Performance rating

Fire protection performance	REI	60
maximum span = 5 m; maximum load $E_{d,fi} = 3,66 \text{ kN/m}^2$ Classified by HFA		
Thermal performance	U Diffusion	0.19 $\text{W}/(\text{m}^2\text{K})$ suitable
Calculated by HFA		
Acoustic performance	$R_w (C;C_{tr})$ $L_{n,w} (C_i)$	48(-3;-7) dB
Assessed by TGM		
Mass per unit area	m	55.20 kg/m^2
Calculation based on gypsum plaster board type DF		

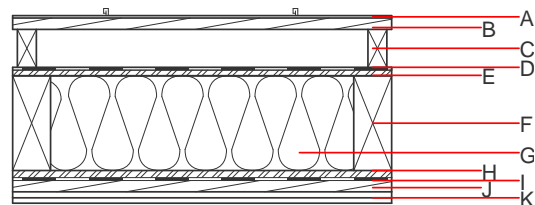
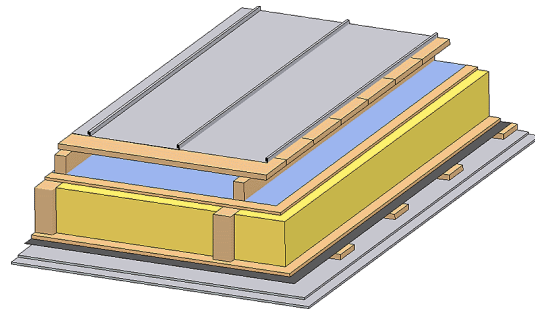

Note: The design of the under-roof construction and of the counter-battens have to be specified according to the roof pitch and the national requirements.

Register of building materials used for this application, cross-section (from outside to inside, dimensions in mm)

Thickness	Building material	Thermal performance				Reaction to fire EN
		λ	μ min – max	ρ	c	
A	Plastic roofing membrane or					E
A	sheet metal roofing			7800		A1
B 24.0	spruce wood closed cladding without spacing of cladding boards	0.120	50	450	1.600	D
C 80.0	spruce wood counter battens (ventilation)	0.120	50	450	1.600	D
D	sarking membrane $s_d \leq 0,3\text{m}$			1000		E
E 15.0	OSB	0.130	200	600	1.700	D
F 220.0	construction timber (80/..; e=800)	0.120	50	450	1.600	D
G 220.0	mineral wool [040; ≥ 16 ; $< 1000^\circ\text{C}$]	0.040	1	16	1.030	A1
H 15.0	OSB	0.130	200	600	1.700	D
I	vapour barrier $s_d \geq 11\text{m}$			1000		
J 24.0	spruce wood cladding with spacing of cladding boards(24/100); a=400	0.120	50	450	1.600	D
K 25.0	gypsum plaster board type DF (2x12,5 mm) or	0.250	10	800	1.050	A2
K 25.0	gypsum fibre board (2x12,5 mm)	0.320	21	1000	1.100	A2

Sustainability rating (per m^2)

Database ecoinvent

$OI3_{kon}$ 39.3

Calculated by HFA

Details of sustainability rating

Database ecoinvent

Lifecycle (Phases)	GWP [kg CO ₂ -e.]	AP [kg SO ₂ -e.]	EP [kg PO ₄ -e.]	ODP [kg R11-e.]	POCP [kg Ethen-e.]	
A1 - A3		0.181	0.083	3,08E-6	0.036	

Lifecycle (Phases)	PERE [MJ]	PERM [MJ]	PERT [MJ]	PENRE [MJ]	PENRM [MJ]	PENRT [MJ]
A1 - A3	141.982	738.687	880.668	601.600	30.376	631.976